

# Installation, Operation and Maintenance Manual Oil Fired Warm Air Furnaces

## HTL (Up-Flow Model)

ALL INSTALLATIONS MUST MEET ALL  
LOCAL, PROVINCIAL/STATE, AND  
FEDERAL CODES WHICH MAY  
DIFFER FROM THIS MANUAL



**Olsen**  
*Heating & Cooling Products*

**Airco**  
*Heating & Cooling Products*

**ECR International Limited  
OLSEN Division**

Read this complete manual before beginning installation. These instructions must be kept with the furnace for future reference.

## TABLE OF CONTENTS

1. INTRODUCTION .....	3
2. HEAT LOSS .....	3
3. LOCATION OF UNIT .....	3
4. AIR CONDITIONING APPLICATIONS .....	3
5. COMBUSTION AIR .....	4
6. CHIMNEY VENTING .....	4
9. OPTIONAL SIDE WALL VENTING.....	6
10. FAN / LIMIT CONTROL .....	6
11. ELECTRICAL CONNECTIONS.....	6
12. HUMIDIFIER.....	6
13. PIPING INSTALLATION .....	7
14. OIL FILTER .....	7
15. OIL BURNER NOZZLES.....	7
16. OIL BURNER ADJUSTMENT .....	7
17. BURNER ELECTRODES.....	7
18. BURNER PRIMARY (SAFETY) CONTROL.....	7
19. COMBUSTION CHAMBER.....	7
20. CIRCULATING AIR BLOWER.....	8
21. MAINTENANCE AND SERVICE.....	8
22. OPERATING INSTRUCTIONS.....	9
A.1 OIL BURNER AIR ADJUSTMENT .....	11
A.2 BURNER ELECTRODES .....	11
A.3 START UP .....	11
OPERATION OF OIL BURNER .....	16
R7184 DETAILED SEQUENCE OF OPERATION (FIGURE 3).....	17
R7184 LED DIAGNOSTIC LIGHT.....	20
FINAL CHECK OUT .....	26
PARTS LISTING: HIGHBOY MODEL: HTL 100C.....	28

## IMPORTANT:

### SAVE THESE INSTRUCTIONS FOR FUTURE REFERENCE

#### 1. INTRODUCTION

Please read these instructions completely and carefully before installing and operating the furnace.

#### MODEL HTL

Model HTL is an oil fired forced air up-flow furnace with an output capacity range of 79,000 BTU/Hr. to 119,000 BTU/Hr.

#### **CAUTION**

**DO NOT USE GASOLINE, CRANK CASE OIL, OR ANY OIL CONTAINING GASOLINE.**

All models are CSA listed, (NRTL/C) for use with No. 1 (Stove) and No. 2 (Furnace) Oil. Please refer to the tables in Appendix A for performance and dimensional data.

In Canada, the installation of the furnace and related equipment shall be installed in accordance with the regulations of CAN/CSA - B139, *Installation Code For Oil Burning Equipment*, as well as in accordance with local codes.

In the United States of America, the installation of the furnace and related equipment shall be installed in accordance with the regulations of NFPA No. 31, *Installation of Oil Burning Equipment*, as well as in accordance with local codes.

Regulations prescribed in the National Codes and Local regulations take precedence over the general instructions provided on this installation manual. When in doubt, please consult your local authorities.

All models are shipped assembled and pre-wired. The furnace should be carefully inspected for damage when being unpacked.

#### 2. HEAT LOSS

The maximum hourly heat loss for each heated space shall be calculated in accordance with the procedures described in the manuals of the Heating, Refrigeration and Air Conditioning Institute of Canada (HRAI), or by any other method which is suitable for local conditions, provided the results obtained are in substantial agreement with and not less than those obtained using the procedure described in the manual.

In the United States, Manual J. titled, "Load Calculation" published by the Air Conditioning Contractors of America, describes a suitable

procedure for calculating the maximum hourly heat loss.

#### 3. LOCATION OF UNIT

The furnace should be located such that the flue connection to the chimney is short, direct and consists of as few elbows as possible. When possible, the unit should be centralized with respect to the supply and return air ductwork. A central location minimizes the trunk duct sizing. All models may be installed on combustible floors.

The minimum installation clearances are listed in Table 1.

**Table 1: Clearances – (Inches)**

Location	Clearance to Combustibles	
	HTL	
	Up flow	
Top	1	
Bottom	0	
S/A Plenum	1	
Rear	1	
Sides	1	
Front	24	
Flue Pipe	9	
Enclosure	Alcove	

#### 4. AIR CONDITIONING APPLICATIONS

If the furnace is used in conjunction with air conditioning, the furnace shall be installed in parallel with or upstream from the evaporator coil to avoid condensation in the heat exchanger. In a parallel installation, the dampers or air controlling means must prevent chilled air from entering the furnace. If the dampers are manually operated, there must be a means of control to prevent the operation of either system unless the dampers are in the full heat or full cool position. The air heated by the furnace shall not pass through a refrigeration unit unless the unit is specifically approved for such service.

The blower speed must be checked and adjusted to compensate for the pressure drop caused by the evaporator coil. Refer to Appendix B for recommended wiring and electrical connections of the air conditioning controls.

## 5. COMBUSTION AIR

If the furnace is installed in a confined area such as a small utility room, two openings must be provided connecting to a well-ventilated space (full basement, living room or other room opening thereto, but not a bedroom or bathroom). One opening shall be located above the level of the upper vent opening and one opening below the combustion air inlet opening in the front of the furnace. Each opening shall have a minimum free area of 1½ square inches per 1,000 Btu/h of total input rating of all appliances installed in the room.

For furnaces located in buildings of unusually tight construction, such as those with high quality weather stripping, caulking, windows and doors, or storm sashed windows, or where basement windows are well sealed, a permanent opening communicating with a well ventilated attic or with the outdoors shall be provided, using a duct if necessary. The duct opening shall have a free area of 1½ square inches per 1,000 Btu/h of total input rating of all appliances to be installed. When a furnace is installed in a full basement, infiltration is normally adequate to provide air for combustion and draft operation. Furnace rooms under 65m<sup>3</sup> (700 ft<sup>3</sup>) should automatically be treated as confined space.

## 6. CHIMNEY VENTING

The flue pipe should be as short as possible with horizontal pipes sloping upward toward the chimney at a rate of one-quarter inch to the foot. The flue pipe should not be smaller in cross sectional area than the flue collar on the furnace. The flue pipe should connect to the chimney such that the flue pipe extends into, and terminates flush with the inside surface of the chimney liner. Seal the joint between the pipe and the lining. The chimney outlet should be at least two feet above the highest point of a peaked roof. All unused chimney openings should be closed. Chimneys must conform to local, provincial or state codes, or in the absence of local regulations, to the requirements of the National Building Code.

**NOTE: THE FURNACE IS APPROVED FOR USE WITH TYPE L VENT OR EQUIVALENT.**

### **CAUTION**

**THE FURNACE MUST BE CONNECTED TO A FLUE HAVING SUFFICIENT DRAFT AT ALL TIMES TO ENSURE SAFE AND PROPER OPERATION OF THE APPLIANCE.**

**NOTE: THE OVER-FIRE DRAFT PRESSURE IS SUFFICIENT WITH A -0.02 IN. W.C. READING**

## MEASURED AT THE BURNER MOUNTING PLATE.

The flue pipe must not pass through any floor or ceiling, but may pass through a wall where suitable fire protection provisions have been installed. Refer to the latest edition of CAN/CSA B-139 for rules governing the installation of oil burning equipment. In the United States, refer to the latest edition of NFPA 31 for regulations governing the installation of oil burning equipment.

See appendix A for burner set-up.

## 7. INSTRUCTIONS FOR OIL FIRED BLOCKED VENT SAFETY KIT

### FOR CHIMNEY VENT USE ONLY

**NOTE: REQUIRED FOR CANADIAN INSTALLATIONS, OPTIONAL FOR UNITED STATES INSTALLATIONS.**

A qualified technician must install this device in accordance with this manufacturer's installation instructions. Wiring must be in accordance with the Canadian Electrical Code and applicable local codes.

### **WARNING**

**READ THESE INSTALLATION INSTRUCTIONS CAREFULLY AND COMPLETELY BEFORE INSTALLING THIS CONTROL.**

### **WARNING**

**DO NOT RESET THE SAFETY DEVICE OR RESTART THE APPLIANCE UNLESS THE CAUSE FOR ITS ACTIVATION HAS BEEN IDENTIFIED AND CORRECTED BY A QUALIFIED TECHNICIAN. ENSURE THE SWITCH AND APPLIANCE HAS BEEN SERVICED BY A QUALIFIED TECHNICIAN PRIOR TO PLACING BACK INTO SERVICE. A QUALIFIED TECHNICIAN MUST PERFORM ANNUAL INSPECTION AND CLEANING.**

Wiring must be in accordance with the current **Canadian Electrical Code** and any other applicable federal, provincial and local code requirements.

If installed within the United States, wiring must be in accordance with the current **National Electrical Code** and any other applicable federal, state and local code requirements.

**⚠ WARNING** FOR CONTINUED SAFE OPERATION, THE APPLIANCE INCLUDING THE SWITCH REQUIRES ANNUAL INSPECTION AND MAINTENANCE BY A QUALIFIED TECHNICIAN. FAILURE TO PROPERLY MAINTAIN THE APPLIANCE AND SWITCH CAN LEAD TO PROPERTY DAMAGE, PERSONAL INJURY OR DEATH.

**Rear Breach Assembly Parts Breakdown**

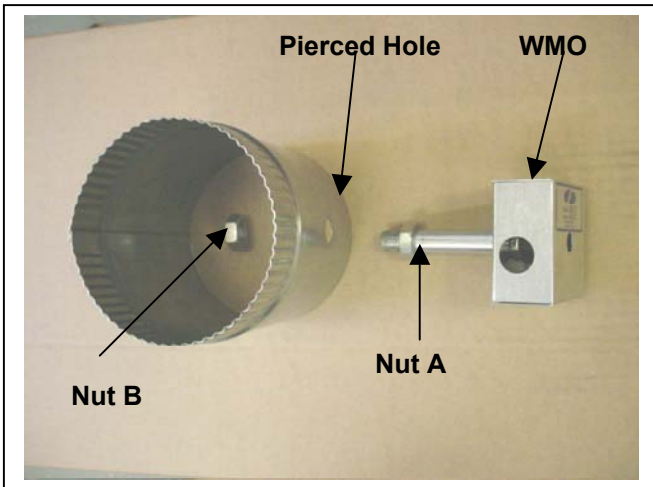

**⚠ CAUTION** ENSURE ELECTRICAL POWER SUPPLY IS DISCONNECTED BEFORE WIRING SAFETY SWITCH.

**INSTALLATION FRONT BREACH WITH VESTIBULE**

1. Remove nut B from the pipe of the safety switch assembly. Tighten nut A onto the heat transfer tube as far as possible.
2. Insert threaded pipe end into the pierced hole of the elbow provided, then install nut B that was removed in step one.
3. Secure elbow onto the breach of the appliance using 3 sheet metal screws.
4. Use the factory supplied wire harness. Similar to the rear breach units, connect end of harness with eyelet connectors to the safety switch and push the heyco bushing in place to secure the wires to the WMO-1 control. (Refer to figure 1). Secure wiring to ensure it does not contact the venting. Using the connectors on the harness, wire safety switch in series with the limit circuit as indicated in the appliance wiring diagrams and figure 2.

**Figure 1: Connections Inside WMO-1**

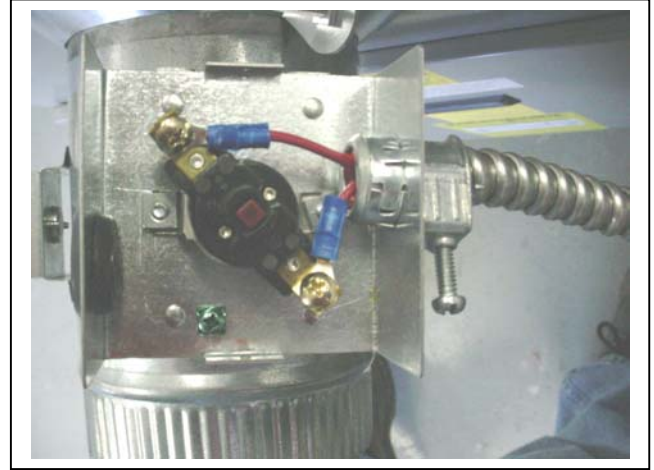

**Figure 2: Wire Connections On Vestibule Units with Fan and Limit Wiring**

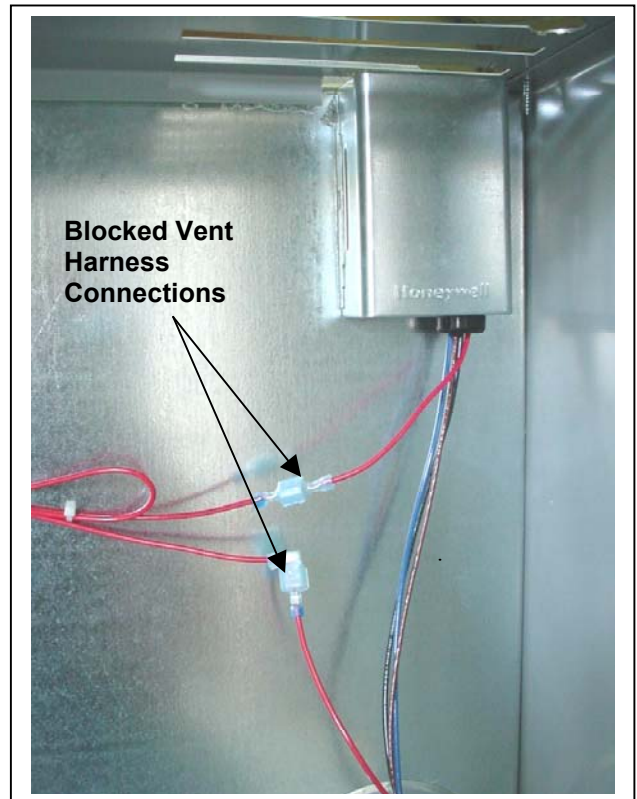

**8. BAROMETRIC DAMPER CONTROL.**

This device is used on conventional chimney venting only. This control (or draft regulator) automatically maintains a constant negative pressure in the furnace to obtain maximum efficiency. It ensures that proper pressures are not exceeded. If the chimney does not develop sufficient draft, the draft control cannot function properly. The draft regulator, when installed should be in the same room or enclosure as the furnace and should not interfere with the combustion

air supplied to the burner. The control should also be located near the furnace flue outlet and installed according to the instructions supplied with the regulator. The flue outlet pressure (measured between the furnace and draft regulator) should be set to -0.02 in. w.c.

## 9. OPTIONAL SIDE WALL VENTING

These furnaces are also approved for use with the Field Controls Co. SWG II-5 power venter. For installation instructions refer to the manual supplied with the venter, and the control package supplied with the power venter. The power venter may be purchased at most HVAC supply houses.

Note: Sidewall venting requires special attention to combustion air supply. There is no natural draft in the venting system between furnace cycles; therefore, if the indoor pressure is negative relative to the outdoors, the vent terminal becomes a point of infiltration. This could lead to oil odour control problems. This problem is rectified by the use of ducted outdoor air for combustion.

## 10. FAN / LIMIT CONTROL

The L6064A temperature sensitive fan switch is actuated by a helical bimetal sensing element enclosed in a metal guard and controls the circulating air blower. This provides a delay between the burner ignition and blower start up to eliminate excessive flow of cold air when the blower comes on. Blower shutdown is also delayed to remove and residual heat from the heat exchanger and improve the annual efficiency of the furnace. Fan settings of 120° F to 130° F (50° C to 55° C) and fan settings of 90° F to 100° F (32° C to 37°C) will usually be satisfactory. The fan switching function of the L6064A is SPDT.

The limit switch performs a safety function and operates to shut off the burner in case of overheating or excessive temperatures. The limit control is thermally operated and automatically resets. The limit control is factory pre-set, and should not be adjusted.

The limit control and fan control are incorporated in the same housing and are operated by the same thermal element.

## 11. ELECTRICAL CONNECTIONS

The furnace is listed by the Canadian Standards Association under the NRTL (North American) Standard. It is factory wired and requires minimal field wiring. All field wiring should conform to CAN/CSA C22.1 Canadian Electrical Code, Part 1, and by local codes, where they prevail. In the United States, the wiring must be in accordance with the National Fire Protection Association NFPA-70, National Electrical Code, and with local codes and regulations.

The furnace should be wired to a separate and dedicated circuit in the main electrical panel; however, accessory equipment such as electronic air cleaners and humidifiers may be included on the furnace circuit. Although a suitably located circuit breaker can be used as a service switch, a separate service switch is advisable. The service switch is necessary if reaching the circuit breaker involves becoming close to the furnace, or if the furnace is located between the circuit breaker and the means of entry to the furnace room. The furnace switch (service switch) should be clearly marked, installed in an easily accessible area between the furnace and furnace room entry, and be located in such a manner to reduce the likelihood that it would be mistaken as a light switch or similar device.

The power requirement for the HTL-C models is: 120 VAC, single phase, 60 Hz., 12A. Power requirement for the HTL-CT models is: 120 VAC, single phase, 60 Hz., 16A.

Accessories requiring 120 VAC power sources such as electronic air cleaners and humidifier transformers may be powered from the furnace circuit, but should have their own controls. Do not use the direct drive motor connections as a power source, since there is a high risk of damaging the accessories by exposure to high voltage from the auto-generating windings of the direct drive motor.

Thermostat wiring connections and air conditioning contactor low voltage connections are shown in the wiring diagrams in Appendix B. Some micro-electronic thermostats require additional controls and wiring. Refer to the thermostat manufacturer's instructions.

The thermostat should be located approximately 5 feet above the floor, on an inside wall where there is good natural air circulation, and where the thermostat will be exposed to average room temperatures. Avoid locations where the thermostat will be exposed to cold drafts, heat from nearby lamps and appliances, exposure to sunlight, heat from inside wall stacks, etc.

The thermostat heat anticipator should be adjusted to the amperage draw of the heating control circuit as measured at the "R" and "W" terminals of the thermostat. To reduce the risk of damaging the heat anticipator, do not measure this current with the thermostat connected to the circuit. Measure the amperage by connecting an ammeter between the two wires that will connect to the thermostat "R" and "W" terminals.

## 12. HUMIDIFIER

A humidifier is an optional accessory available through most heating supplies outlets. Installation should be carried out in accordance with the humidifier manufacturer's installation instructions. Water or water droplets from the humidifier should not be allowed to come into contact with the furnace heat exchanger. Do

not use direct drive motor connections as a source of power for 120 VAC humidifiers and humidifier transformers.

### 13. PIPING INSTALLATION

The entire fuel system should be installed in accordance with the requirement of CAN/CSA B-139, and local regulations. Use only an approved fuel oil tanks piping, fittings and oil filter.

In the United States the installation must be in accordance with NFPA No. 31 and local codes and authorities.

Install the oil filter as close to the burner as possible. For further details of the oil supply tank and piping requirements, please refer to the instructions and illustrations in the oil burner and oil pump instructions shipped with the furnace.

### 14. OIL FILTER

All fuel systems should include an oil filter between the fuel oil storage tank and the oil burner.

### 15. OIL BURNER NOZZLES

The HTL is certified for multiple firing rates, ranging from 79,000 to 119,000 Btu/h. By selecting a nozzle size that most closely matches the calculated building heat loss, the furnace may be fired at an ideal rate for a wide range of structures. Refer to Table A-1, and the furnace rating plate to determine the ideal nozzle.

### 16. OIL BURNER ADJUSTMENT

The burner air supply is adjusted to maintain the *fuel to air ratio* to obtain ideal combustion conditions. A lack of air causes "soft" and "sooty" flames, resulting in soot build-up throughout the heat exchanger passages. Excess combustion air causes a bright roaring fire and high stack temperatures resulting in poor fuel efficiency. The HTL furnace operates most efficiently with an approximate No. 1 smoke spot on the Bacharach Scale. This is not necessarily the optimum setting; however, because dust will inevitably build up on the air moving components of the oil burner assembly. This will result in decreased air supply with the potential result of soot building up in the flue gas passageways of the heat exchanger. Soot behaves as an insulator and impairs good heat transfer. Stack temperature will increase, and the overall efficiency will decrease. As a means of avoiding this problem, it is advisable to adjust the air supply to provide no more than a trace smoke spot on the Bacharach Scale.

**NOTE: FIELD CONTROLS SIDEWALL VENTED MODELS SHOULD BE SET UP TO DELIVER ZERO (0) SMOKE.**

## ⚠ CAUTION

**BEFORE OPERATING THE FURNACE CHECK BURNER ALIGNMENT WITH COMBUSTION CHAMBER. THE END CONE OF THE AIR TUBE MUST BE CENTRED TO THE ACCOMODATING RING PROVIDED IN THE DESIGN OF THE COMBUSTION CHAMBER. ADJUST AS NECESSARY.**

### 17. BURNER ELECTRODES

Correct positioning of the electrode tips with respect to each other, to the fuel oil nozzle, and to the rest of the burners is essential for smooth light ups and proper operation. Refer to the oil burner instructions shipped with the furnace for electrode specifications.

NOTE: Beckett AF Series Burner electrode specifications have been revised. They should be adjusted to be 5/16" above the nozzle centerline. Use of Beckett's "Z" gauge is recommended.

### 18. BURNER PRIMARY (SAFETY) CONTROL

The furnace is equipped with a primary combustion control, sometimes referred to as the burner relay or burner protector relay, which uses a light sensing device (cad cell) located in the burner housing, to monitor and control combustion. Over time, dust or combustion residuals can build up on the lens of the cad cell impairing its response to the flame. The cad cell should be checked for cleanliness and proper alignment if the primary control frequently shuts down combustion.

## ⚠ CAUTION

**ALL FURNACE CONTROLS ARE SENSITIVE AND SHOULD NOT BE SUBJECTED TO TAMPERING. IF PROBLEMS PERSIST, CALL YOUR SERVICE CONTRACTOR.**

### 19. COMBUSTION CHAMBER

This furnace is equipped with a high quality cerafelt combustion chamber. It is held in place by a retaining bracket.

**CHECK THE ALIGNMENT OF THE COMBUSTION CHAMBER AND OIL BURNER BEFORE FIRING. IT IS POSSIBLE FOR THE COMBUSTION CHAMBER TO SHIFT IF SUBJECTED TO ROUGH HANDLING DURING TRANSIT.** The combustion chamber should be inspected for damage or carbon build up whenever the oil burner is removed for repairs or routine maintenance.

**CAUTION**

**DO NOT START THE BURNER UNLESS THE BLOWER ACCESS DOOR IS SECURED IN PLACE.**

## 20. CIRCULATING AIR BLOWER

The HTL furnace may be equipped with either a Direct Drive blower systems, or a Belt Drive blower system.

### Direct Drive

Direct drive blower speed adjustments are not normally required in properly sized extended plenum duct systems. The motor RPM and air CFM delivery will vary automatically to accommodate conditions within the usual range of external static pressures typical of residential duct systems. Under-sized duct systems may require a higher blower speed to obtain a reasonable system temperature rise. Some older duct systems were not designed to provide static pressure. They typically feature special reducing fittings at each branch run and lack block ends on the trunk ducts. These systems may require modification to provide some resistance to the airflow to prevent over-amping of the direct drive blower motor. Selecting a lower blower speed may correct this problem. Direct drive blower speeds are adjusted by changing the "hot" wires to the motor winding connections. Please refer to wiring diagrams in Appendix B or the wiring diagram label affixed to the furnace. **THE NEUTRAL WIRE (normally the white wire) IS NEVER MOVED TO ADJUST THE BLOWER SPEED.**

It is possible and acceptable to use a single blower speed for both heating and cooling modes. The simplest method to connect the wiring from both modes is to use a "piggy-back connector" accommodating both wires on a single motor tap. It is also acceptable to connect the selected motor speed with a pigtail joined to both heating and cooling speed wires with a wire nut. As a safety precaution against accidental disconnection of the wires by vibration, it is advisable to secure the wire nut and wires with a few wraps of electricians tape.

**CAUTION**

**DO NOT CONNECT POWER LEADS BETWEEN MOTOR SPEEDS. THE NEUTRAL WIRE MUST ALWAYS BE CONNECTED TO THE MOTOR'S DESIGNATED NEUTRAL TERMINAL.**

If the joining of the blower speed wiring is done in the furnace junction box, tape off both ends of the unused wire.

**Do not use the blower speed wires as a source of power to accessories as electronic air cleaners and humidifier transformers unless it is certain that only one motor speed will be used.** The unused motor taps auto-generate sufficiently high voltages to damage accessory equipment.

### Belt Drive

If the blower is a belt drive type with a pulley and V-belt system, air delivery and system temperature rise may be varied by adjusting the variable-speed motor pulley. The circulating air blower adjustment must be such as to obtain an air temperature rise specified on the rating plate.. Loosen the set screw in the pulley outer flange, close the pulley to increase speed and decrease air temperature rise; open the pulley to decrease the speed and increase the air temperature rise. Align the motor and blower pulley to minimize noise and belt wear. Check belt tension by flexing belt midway between the pulleys. Correct belt tension permits approximately 1" flexing. Too much tension will cause motor to overload and bearing wear, too little tension will permit belt slippage. The recommended minimum return air temperature is 50°F (10°C).

**WARNING**

**DISCONNECT THE POWER SUPPLY TO THE FURNACE BEFORE OPENING THE BLOWER ACCESS DOOR TO SERVICE THE AIR FILTER, FAN AND MOTOR. FAILURE TO SHUT OFF POWER COULD ALLOW THE BLOWER TO START UNEXPECTEDLY, CREATING A RISK OF DEATH OR PERSONAL INJURY.**

## 21. MAINTENANCE AND SERVICE

### A: Routine Maintenance By Home Owner

Other than remembering to arrange for the annual professional servicing of the furnace by the service or installation contractor, the most important routine service performed by the homeowner is to maintain the air filter or filters. A dirty filter can cause the furnace to over-heat, fail to maintain indoor temperature during cold weather, increase fuel consumption and cause component failure.

The furnace filter(s) should be inspected, cleaned or replaced monthly. The furnace is factory equipped with a semi-permanent type filter. If the filter is damaged, replace with filters of the same size and type. (See Appendix A, Table A-8).

During the routine service, inspect the general condition of the furnace watching for signs of oil leaks in the vicinity of the oil burner, soot forming on any external part of the furnace, soot forming around the joints in the vent pipe, etc. If any of these conditions



are present, please advise your service or installation contractor.

### Annual Service By Contractor

#### **CAUTION**

**THE COMBUSTION CHAMBER (FIREPOT) IS FRAGILE. USE CARE WHEN INSPECTING AND CLEANING THIS AREA.**

The heat exchanger should be inspected periodically and cleaned if necessary. If cleaning is necessary, **SHUT OFF POWER TO THE FURNACE** and remove the burner. Using a stiff brush with a wire handle, brush off scale and soot from inside the drum and flue pipe. To clean the radiator, remove the round covers on the inner front panel to gain access to the cleaning ports. When this procedure is done for the first time, carefully cut away the insulation covering the opening with a sharp knife. Loosen the nuts on the radiator clean-outs. **DO NOT REMOVE THE NUTS.** Remove the covers carefully to avoid tearing the gaskets. A wire brush can be used to loosen dirt and debris on the inside surfaces of the radiator. Clean out all accumulated dirt, soot and debris with a wire handled brush and an industrial vacuum cleaner. Before replacing the clean-out covers, inspect the gaskets. If the gaskets are broken, remove the remnants and replace with new gaskets. Snug the cleanout covers. **DO NOT OVER-TORQUE THE CLEAN-OUT NUTS.** Replace the inner front panel clean-out covers.

**NOTE:** A radiator clean-out assembly inadvertently dropped into the interior of the furnace can usually be easily retrieved with a magnet on a wire handle or stout string.

The blower motor is factory oiled. Under normal operating conditions it does not require additional oiling. If the blower motor is equipped with oil ports, oil sparingly (a few drops) in each oil port with SAE 20 non-detergent oil. Oiling is most easily done with a "tele-spout" oiler. This oiler has a long flexible plastic spout. **DO NOT OVER-LUBRICATE.** Excess oil causes premature electric motor failure.

Inspect the blower fan. Clean if necessary.

Oil Burner Maintenance: Follow the instructions of the oil burner manufacturer. (See oil burner manufacturer's instructions supplied with furnace or burner). It is advisable to change the oil burner nozzle and oil filter on an annual basis.

The venting system should be cleaned and inspected for signs of deterioration. Replace pitted or perforated vent pipe and fittings. The barometric damper should open and close freely.

All electrical connections should be checked to ensure tight connections. Safety controls such as the high limit

controls should be tested for functionality. The fan control should be checked to ensure that the fan on and off delay function continues to start and stop the blower fan at the prescribed settings.

## 22. OPERATING INSTRUCTIONS

### BEFORE LIGHTING

1. Open all supply and return air registers.
2. Open all valves in oil pipes.
3. Turn on electric power supply

### TO LIGHT UNIT

1. Set the thermostat to call for heat. The burner should start.

**NOTE:** It may be necessary to press the RESET button on the primary combustion control relay.

2. After a short period of time the blower should start.

3. Set the thermostat down to lowest setting. The burner should stop.

4. The air circulation blower remains in operation as long as the temperature in the furnace is higher than the "FAN OFF" setting on the fan control. If the air at the room registers is uncomfortably high upon blower start up, or shutdown, set the temperature on the fan control to a lower setting.

5. To check the operation of the limit switch, for belt drive units, shut power off to unit and remove the fan belt, for direct drive units disconnect the neutral wire from the motor and isolate it, turn power back on and set the thermostat to call for heat. After three or four minutes of burner operation, the limit control should turn the burner off. Shut power off to the unit, replace fan belt, replace neutral wire, turn power back on. The blower will run until the heat exchanger cools down.

### TO SHUT DOWN UNIT

1. Set the thermostat to the lowest possible setting.
2. Set the manual switch (if installed) in the Electrical Power Supply Line to "OFF".
3. If the burner is to shut down for an extended period of time, close the oil valve tightly.

**▲ CAUTION**

DO NOT ATTEMPT TO START THE BURNER WHEN EXCESS OIL HAS ACCUMULATED, WHEN THE FURNACE IS FULL OF VAPOUR, OR WHEN THE COMBUSTION CHAMBER IS VERY HOT. NEVER BURN GARBAGE OR PAPER IN THE FURNACE, AND NEVER LEAVE PAPER OR RAGS AROUND THE UNIT.

Burner information for the HTL series furnace.

**Table A-1 Beckett AF Oil Burner Set-Up**

Beckett AF Series Oil Burner							
Furnace Model	Output BTU/Hr	Burner Model	Nozzle	Pump Pressure	Flow Rate	Head <sup>1</sup>	Static Plate
HTL-80C	79,000	AF65XN	0.65 / 80°A	100 PSIG	0.65 USGPH	F3	2-¾ in.
HTL-90C	90,000	AF65XN	0.75 / 80°A	100 PSIG	0.75 USGPH	F3	2-¾ in.
HTL-100C	101,000	AF65XN	0.85 / 80°A	100 PSIG	0.85 USGPH	F3	2-¾ in.
HTL-120C	119,000	AF65XN	1.00 / 60°A	100 PSIG	1.00 USGPH	F3	2-¾ in.

### A.1 OIL BURNER AIR ADJUSTMENT

For complete details, consult the oil burner instruction manual provided in the furnace documents envelope.

#### Beckett AF Burner

Adjust the air shutter by loosening the locking screws and moving the air shutter, and if necessary, the bulk air band.

### A.2 BURNER ELECTRODES

Adjustment of the electrode tips with respect to each other, the nozzle, and to the rest of the burner is very important to ensure smooth start-ups and to permit efficient combustion.

#### Beckett AF Burner

Electrode gap: 5/32 inch.

Distance above horizontal centerline: 5/16 inch. Older instruction sheets specify 7/16 inch. The current specification is 5/16 inch.

Distance ahead of nozzle: 1/16 inch.

“Z” dimension, the distance from the front of the end cone (head) to the face of the nozzle should be 1-1/8 inches. If a ceramic head is used, the distance from the end cone to the nozzle face is increased to 1-3/8 inches.

### A.3 START UP

The furnace should be operated for a minimum of 15 minutes to reach steady state conditions before fine tuning combustion. The warm up time is ideal for testing the oil pump pressure.

Drill a 1/4-inch test port in the venting between the furnace flue outlet and draft regulator (barometric

damper). Insert a stack thermometer and note the flue gas temperature. The flue gases should be within a range of 350°F to 450°F. If the flue gases are below the range, it may be necessary to slow down the blower fan. If the flue gases are above the range, the blower fan may require speeding up. Stack temperature varies directly with the system temperature rise. System temperature rise is the difference between the furnace outlet temperature and furnace inlet temperature as measured in the vicinity of the connection between the plenum take-offs and the trunk ducts. Typical temperature rise values range between 65°F and 95°F.

Perform a smoke spot test. The smoke spot should not exceed No. 1 on the Bacharach Scale.

After the air adjustments have been completed, re-check the draft pressure at the furnace burner mounting plate. The draft should be adjusted to 0.02 inches w.c.

In the United States, the Beckett AF Burner may be equipped with Beckett's "Inlet Air Shut-Off" to increase efficiency. (Beckett Part No. AF/A 5861).

**NOTE: USE OF THE INLET AIR SHUT-OFF COULD CAUSE POST COMBUSTION NOZZLE DRIP RESULTING IN HIGHER SMOKE LEVELS AND PREMATURE SOOTING OF THE HEAT EXCHANGER.**

**Table A-2 Direct Drive Blower Set-Up**

Furnace Model	Blower	Blower Set-Up				Cooling Capacity		
		0.20 in. w.c.		0.50 in. w.c.		Tons	Power	CFM Range
		Speed	Motor	Speed	Motor			
HTL-80C	G10 DD	Med-High	1/2 HP	Med-High	1/2 HP	3 – 4	1/2 HP	1000 – 1600
HTL-90C	G10 DD	Med-High	1/2 HP	High	1/2 HP	3 – 4	1/2 HP	1000 – 1600
HTL-100C	G10 DD	High	1/2 HP	High	1/2 HP	3 – 4	1/2 HP	1000 – 1600
HTL-120C	G10 DD	High	1/2 HP	High	1/2 HP	3 – 4	1/2 HP	1000 – 1600
HTL-80CT	GT12-11 DD	Low	1 HP	Low	1 HP	3 – 4½	1 HP	1200 - 1750
HTL-90CT	GT12-11 DD	Low	1 HP	Low	1 HP	3 – 4½	1 HP	1200 – 1750
HTL-100CT	GT12-11 DD	Low	1 HP	Med	1 HP	3 – 4½	1 HP	1200 – 1750
HTL-120CT	GT12-11 DD	Low	1 HP	High	1 HP	3 – 4½	1 HP	1200 - 1750

**Table A-3 Belt Drive Blower Set-Up**

Furnace Model	Blower	Blower Set-Up								Cooling Capacity		
		0.20 in. w.c.				0.50 in. w.c.				Tons	Motor	CFM Range
		Pulley		Belt	Motor	Pulley		Belt	Motor			
		Motor	Blower			Motor	Blower					
HTL-80C	G10	3¼ x ½	5 x ¾	4L350	1/2 HP	3¼ x ½	5 x ¾	4L350	1/2 HP	3 – 4	1/2 HP	1000 – 1600
HTL-90C	G10	3¼ x ½	5 x ¾	4L350	1/2 HP	3¼ x ½	5 x ¾	4L350	1/2 HP	3 – 4	1/2 HP	1000 – 1600
HTL-100C	G10	3¼ x ½	5 x ¾	4L350	1/2 HP	3¼ x ½	5 x ¾	4L350	1/2 HP	3 – 4	1/2 HP	1000 – 1600
HTL-120C	G10	3¼ x ½	5 x ¾	4L350	1/2 HP	3¼ x ½	5 x ¾	4L350	1/2 HP	3 – 4	1/2 HP	1000 – 1600

**Table A-4 Direct Drive Blower Characteristics**

Furnace Model	Blower	Motor HP	Motor FLA	ΔT	Speed	CFM				
						External Static Pressure – Inches w.c.				
						0.20	0.30	0.40	0.50	0.60
HTL 80 – 120	G10 DD	1/2 HP	7.0	70°F	High	1637	1578	1512	1448	1364
					Med-High	1542	1500	1438	1358	1279
					Med-Low	1153	1142	1126	1100	1058
					Low	755	750	739	720	691
HTL 80 – 120 T	GT12-11 DD	1 HP	14.0	70°F	High	1896	1839	1770	1717	1654
					Med	1785	1737	1673	1629	1560
					Low	1631	1592	1548	1506	1452

**Table A-5 Belt Drive Blower Characteristics**

Furnace Model	Motor HP	Motor FLA	ΔT	Blower	Blower Pulley	Motor Pulley Turns Out	CFM					
							External Static Pressure – Inches w.c.					
							0.20	0.25	0.30	0.40	0.50	0.60
HTL 80 - 120	1/2 HP	7.8	70°F	GT10	5 x ¾	0	1385	1355	1325	1260	1189	1118
						2	1255	1222	1189	1124	1045	962
						4	1151	1116	1081	991	893	786
						6	995	974	952	905	854	803

**TIP:**

These Formulae will assist with the design of the ductwork and the determination of airflow delivery:

$$CFM = \frac{\text{Bonnet Output}}{(1.085 \times \text{System Temperature Rise})}$$

$$\text{System Temperature Rise} = \frac{\text{Bonnet Output}}{(1.085 \times CFM)}$$

**Table A-9: General Dimensions (Inches)**

CABINET			PLENUM OPENINGS		FLUE		FILTER (PERM)	SHIP WEIGHT
WIDTH	DEPTH	HEIGHT	SUPPLY	RETURN	DIAM.	HEIGHT		
HTL								
22"	31"	58"	20½" x 20"	14" x 22"	6"	55 ½"	16" x 25" x 1"	270 lbs

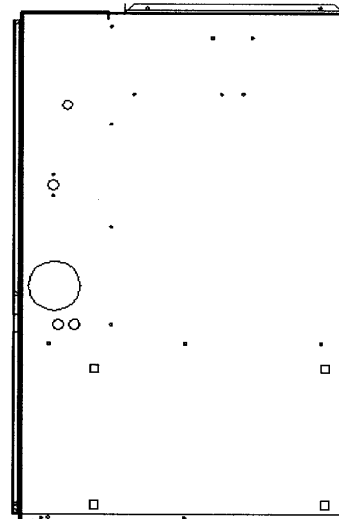
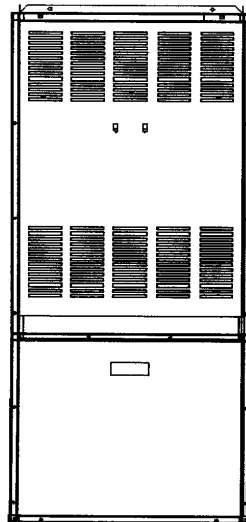
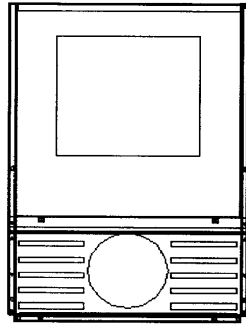

# APPENDIX B: WIRING DIAGRAMS

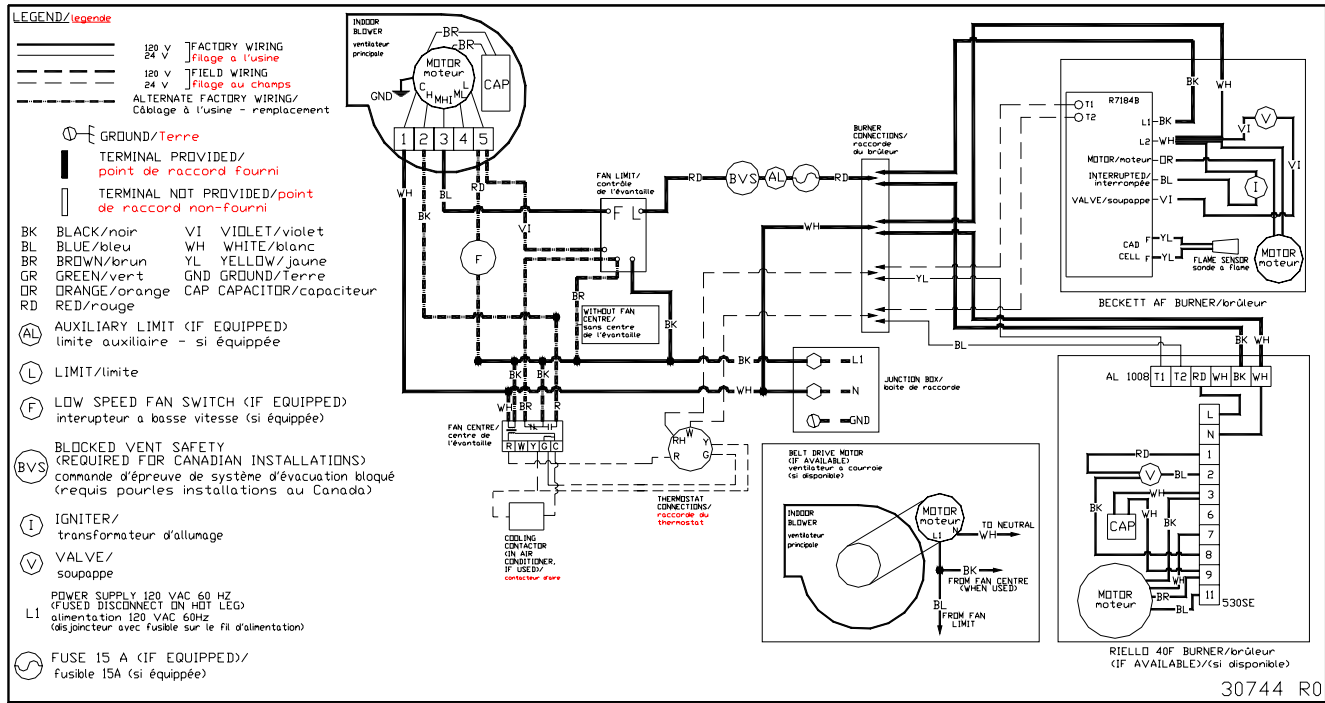

## OPERATION OF OIL BURNER

Once the furnace flue pipe, electrical and oil line connections have been made, use the following instructions to set the burner:

1. Shut off the electrical power to the furnace.
2. Install an oil pressure gauge to the pressure port on the oil pump. (Refer to the oil pump specification sheet included with the burner instructions).
3. Restore electrical power to the furnace.
4. Start the furnace and bleed all air from the fuel oil lines.
5. Close the purge valve and fire the unit.
6. Allow the furnace to warm up to normal operating temperatures. During this time, set the pump pressure in accordance with the data provided in Appendix A, Table A-1.
7. When the furnace has reached "*steady state*" (after approximately 15 minutes). Set combustion air damper to get a TRACE of smoke.
8. Check the system temperature rise. The temperature rise is the difference between the return air temperature measured at a point near the return air inlet, and the supply air temperature measured near the furnace outlet. The system temperature rise will typically range between 65°F and 95°F. If the temperature rise is too high, the airflow must be increased. If the temperature rise is too low, the fan should be slowed down.
9. Turn off the burner. Observing the duct thermometer in the supply air stream, note the temperature at which the blower fan stops. Fan on/off adjustments can be made by moving the "fan off" and "fan on" levers on the L6064A Fan/Limit dial. The fan off setting should stop the blower when the supply air temperature reaches 90° to 100°F. The "fan on" lever is usually set 30° higher.

To check the operation of the limit switch, for belt drive units, shut power off to unit and remove the fan belt, for direct drive units disconnect the neutral wire from the motor and isolate it, turn power back on and set the thermostat to call for heat. After three or four minutes of burner operation, the limit control should turn the burner off. Shut power off to the unit, replace fan belt, replace neutral wire, turn power back on. The blower fan will start up immediately. Once the temperature has dropped and the limit control has reset, the fan will operate until the fan off temperature is reached. Once the limit has reset, the oil burner will resume operation and continue until the thermostat is satisfied.

Restore the thermostat setting to a comfortable temperature.

10. Set the heat anticipator adjustment in the thermostat (if so equipped) to the amperage draw of the heating control circuit as measured at the "R" and "W" terminals of the thermostat. To reduce the risk of damaging the heat anticipator, do not measure this current with the thermostat connected to the circuit. Measure the amperage by connecting an ammeter between the two wires that will connect to the thermostat "R" and "W" terminals.

**NOTE: THE FURNACE SHOULD BE RUN THROUGH AT LEAST THREE FULL CYCLES BEFORE LEAVING THE INSTALLATION, TO ENSURE THAT ALL CONTROLS ARE OPERATING PROPERLY AND AS EXPECTED.**



---

<h2>Appendix C</h2> <p>Troubleshooting</p>
--------------------------------------------

### R7184 DETAILED SEQUENCE OF OPERATION (FIGURE 3)

Power is applied to unit. The R7184 completes a self-diagnostic procedure. If no light or flame is present, and unit passes its self-diagnostic procedure, the control enters into the idle mode.

*Thermostat calls for heat:*

- A) Safety check is made for flame (5 second delay).
  - 1) If flame is not present, the R7184 will apply power to the burner motor and igniter.
  - 2) If flame is present, the control remains in the idle state.
- B) Unit enters a pre-purge period of 15 seconds.
- C) After 10 seconds, control checks for flame presence.
  - 1) If flame is not present, the R7184 enters the trial for ignition state.
  - 2) When flame is present, the control enters lock out mode.
- D) Control monitors the burner flame.
  - 1) When flame is present, the control enters ignition carryover state. (Continues to spark for 10 sec.).
    - a) Provides continuous spark after flame is sensed to assure that burner remains lit.
    - b) Turns on LED diagnostic light.
    - c) Starts carryover timer.
      - (i) Flame and call for heat are monitored.
        - If flame is lost and lockout timer has not expired, R7184 will return to trial for ignition state.
        - If flame is lost and lockout timer has expired, R7184 will enter the recycle state.
          - ◆ Recycle timer starts.
          - ◆ Burner motor and igniter and solenoid valve are turned off.
          - ◆ LED diagnostic light flashes slowly.
- E) Carryover timer expires.
  - 1) Enters run state.
    - a) Igniter turns off.

*Combustion continues until thermostat is satisfied, or R7184 detects a loss of flame and enters into Recycle Mode.*

- F) Thermostat is satisfied - call for heat is terminated:
  - a) R7184 shuts off burner motor and solenoid valve.
    - (i) If control utilizes a blower motor off delay, after 30 seconds, flame presence is checked.
      - If flame is not present, the R7184 LED diagnostic light is off and returns to idle state.

If flame is presence is detected, the control enters lock out mode.

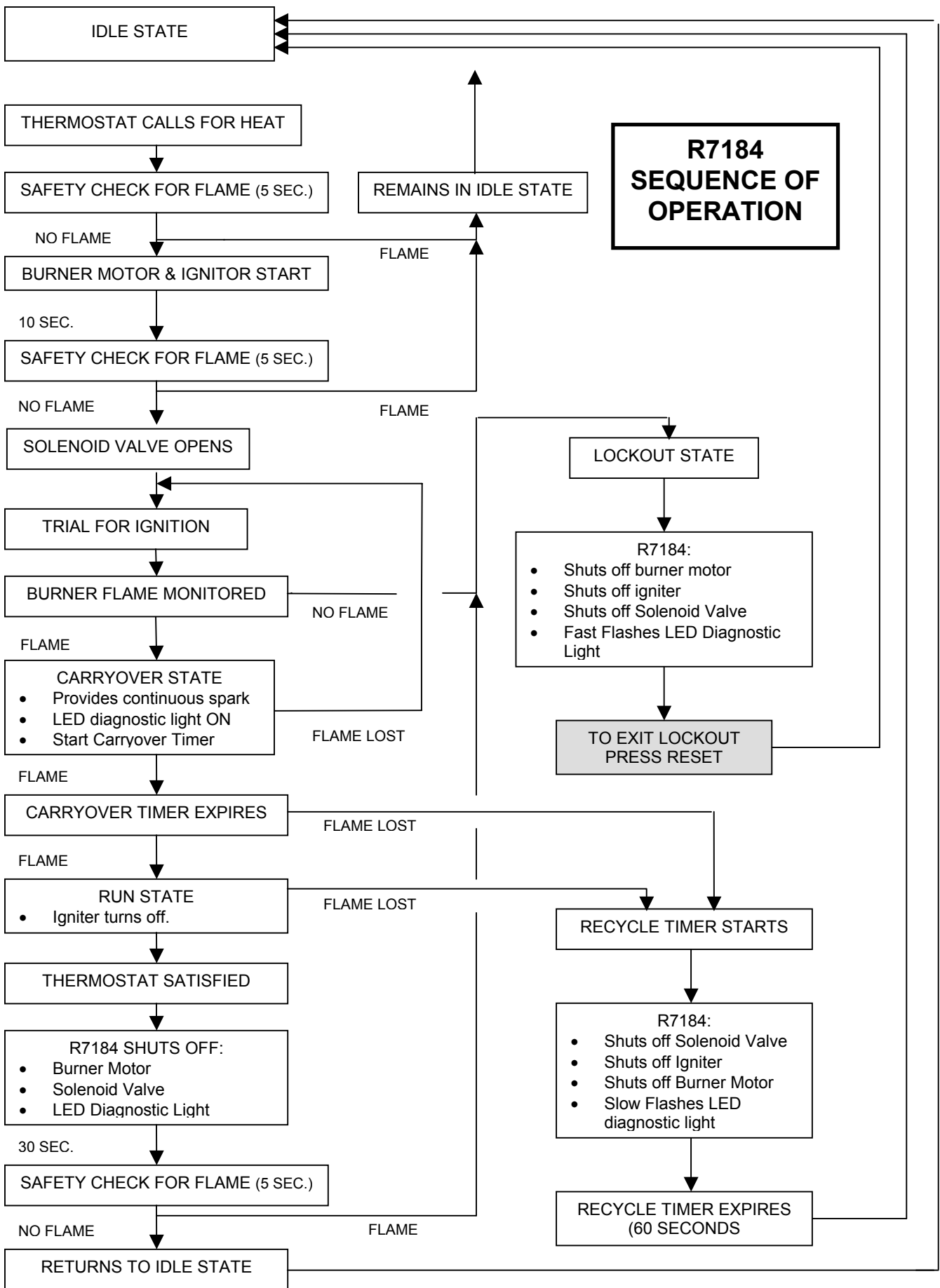
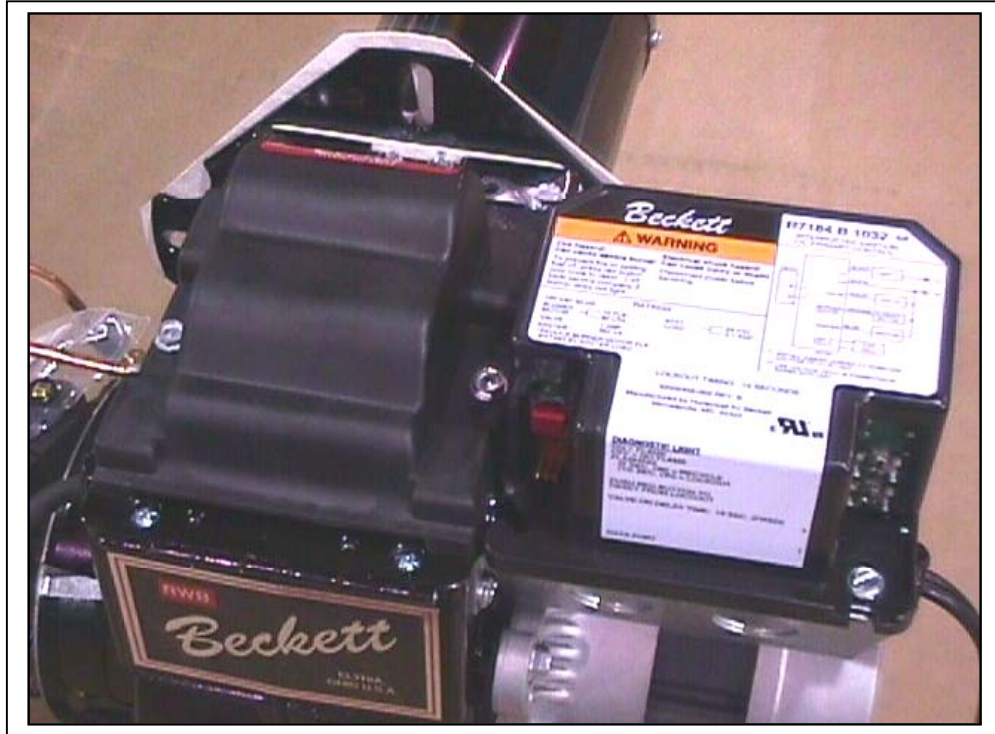

Figure 3: R7184 Oil Primary Control



## R7184 LED DIAGNOSTIC LIGHT

The LED diagnostic light has several functions. It indicates the state or mode in which the oil burner is operating. It will also indicate fault conditions, and help determine cad cell resistance while the burner is operating.

### NORMAL CONDITIONS:

The LED diagnostic light will turn on when the burner enters the carryover state; the point at which ignition spark is on, and will remain on through the run state, where the ignition spark is terminated but the burner continues to fire.

The LED diagnostic light will turn off at the end of the burner cycle as the R7184 enters the idle state, and will remain off until the next heating cycle.

### FAULT CONDITIONS:

If the LED diagnostic light is flashing quickly; 1 Hz (½ second on / ½ second off), the R7184 is in the lockout state or in restricted mode. To exit the lockout state, press the reset button.

If the LED diagnostic light is flashing slowly; ¼ Hz (2 seconds on / 2 seconds off), the R7184 is in the recycle state. This indicates that flame sensing was lost after the lockout timer expired during the ignition carryover state. The R7184 will return to the idle state within 60 seconds.

### CAD CELL CONDITION:

If the LED diagnostic light is off, the cad cell is not sensing flame.

If the LED diagnostic light is on, the cad cell is sensing flame, or viewing ambient light.

The resistance of the cad cell may be checked while the R7184 is in the run state by pressing the reset button. The LED diagnostic light will flash the following code:

**Table C-2: Cad Cell Resistance**

Flashes	Resistance in Ohms
1	Less than 400
2	Between 400 - 800
3	Between 800 – 1600
4	Between 1600 - 5000

### Troubleshooting

**IMPORTANT:** Due to the potential hazard of line voltage, only a trained, experienced service technician should perform the troubleshooting procedure.

## PRELIMINARY STEPS:

Check the diagnostic light for indications of burner condition. Refer to R7184 LED DIAGNOSTIC LIGHT section for details.

### **CAUTION**

**WHEN SIMULATING A CALL FOR HEAT AT THE R7184, DISCONNECT AT LEAST ONE THERMOSTAT LEAD WIRE FROM THE T1 - T2 TERMINALS TO PREVENT DAMAGE TO THE THERMOSTAT. NEGLECTING THIS PROCEDURE MAY BURN OUT THE HEAT ANTICIPATOR OF A STANDARD 24 VAC THERMOSTAT, OR CAUSE HARM TO COMPONENTS WITHIN A MICRO-ELECTRONIC THERMOSTAT.**

Before checking the oil primary control, perform these preliminary checks, (repair or replace controls as necessary):

- Check the power supply; fuse box or breaker, any service switches, all wiring connections, and burner motor reset button (if equipped).
- Check the limit switches to ensure that the switch contacts are closed.
- Check the electrode gap and position.
- Check the contacts between the oil primary control and the electrodes.
- Check oil supply (tank gauge).
- Check the oil nozzle, oil filter, and oil valves.
- Check the piping or tubing to the oil tank.
- Check the oil pump pressure.

### Check Oil Primary Control and Igniter

If the trouble does not appear to be in the burner or ignition hardware, check the oil primary control and the igniter by using the following equipment:

Insulated jumper wires with both ends stripped.

Screwdriver, Voltmeter (0 - 150 VAC)

### **WARNING**

**ELECTRICAL SHOCK HAZARD.**

**TROUBLESHOOTING IS DONE WITH THE SYSTEM POWERED. BE CAREFUL TO OBSERVE ALL NECESSARY PRECAUTIONS TO PREVENT ELECTRICAL SHOCK OR EQUIPMENT DAMAGE.**

**Preliminary Checks:**

Make sure that limit switches are closed and contacts are clean.

Check for line voltage power on the oil primary control black and white lead wires.

Refer to Table C-4 or C-5 for further troubleshooting information.

**Table C-3: R7184 TROUBLESHOOTING. Condition: Burner motor does not start when there is a call for heat.**

Procedure	Status	Corrective Action
1. Check that limit switches are closed and contacts are clean.	N/A	N/A
2. Check for line voltage power at the oil primary control. Voltage should be 120 Vac between the black and white lead wires on the oil primary control.	N/A	N/A
3. Check indicator light with burner off, no call for heat (no flame).	Indicator light is on.	Cad cell is defective, sees external light, or connections have shorted. Go to step 4.
	Indicator light is off.	Go to step 5.
4. Shield cad cell from external light.	Indicator light turns off.	Eliminate external light source or permanently shield cad cell.
	Indicator light stays on.	<ul style="list-style-type: none"> <li>• Replace cad cell with new cad cell and recheck.</li> <li>• If indicator light does not turn off, remove yellow lead wires from R7184 and recheck.</li> <li>• If indicator light is still on, replace the R7184 control.</li> <li>• If the indicator light turns off, replace cad cell bracket assembly.</li> </ul>
5. Jumper thermostat (T -T) terminals on R7184	Burner starts.	Trouble is in thermostat circuit. Check thermostat-wiring connections. If connections are clean and tight, check thermostat wires for continuity.
	<b>IMPORTANT</b> First remove one thermostat lead wire.	Burner does not start.
If burner still doesn't start, check the oil burner motor. It may be seized or burned out.		

**Condition: Burner starts then locks out on safety with indicator light flashing at 1 Hz rate (1/2 second on, 1/2 second off)**

Procedure	Status	Corrective Action
1. Check that the limit switches are closed and contacts are clean.	---	---
2. Check for line voltage power at the oil primary control. Voltage should be 120 vac (nominal)	---	---
3. Check indicator light with burner off, no call for heat (no flame).	Indicator light is on.	Cad cell or controller is defective, sees external light, or connections are shorted. Go to step 4.
	Indicator light is off.	Go to step 5.
4. Shield cad cell from external light.	Indicator light turns off.	Eliminate external light source or permanently shield cad cell.
	Indicator light stays on.	4. Replace cad cell with new cad cell and recheck. 5. If indicator light does not turn off, remove cad cell lead wires from R7184 and recheck. 6. If indicator light turns off, replace cad cell bracket assembly. 7. If indicator light does not turn off, replace controller.
5. Jumper thermostat (T -T) terminals on R7184  <b>IMPORTANT</b> First remove one thermostat lead wire.	Burner starts.	Trouble in thermostat or limit circuit. Check thermostat or limit wiring connections.
	Burner does not start.	Disconnect the line voltage power and open line switch. Check all wiring connections. Tighten any loose connections and recheck. If burner does not start, replace R7184
6. Reset oil primary control by pushing in and releasing red reset button.	Indicator light stops flashing.	Go to Step 7.
	Indicator light continues to flash at 1 Hz rate.	Verify that the control is not in restricted mode. (See notes at end of this table.). If not in restricted mode, replace R7184
7. Listen for spark after burner turns on (after 2 second delay).	Ignition is off	Spark igniter could be defective. Check for line voltage at igniter terminals. If line voltage is present, replace R7484.
	Ignition is on.	Go to Step 8.
	Ignition is on but no oil is being sprayed into the combustion chamber.	Wait for "Valve ON" delay to complete. Check oil supply, and oil line valve. Check for filter blockage or seized oil pump.
8. Check indicator light after flame is established, but before oil primary control locks out.	Indicator light is on until the control locks out and starts flashing during lockout.	Replace R7184
	Indicator light stays off.	Go to step 9.

**Condition: Burner starts then locks out on safety with indicator light flashing at 1 Hz rate  
(1/2 second on, 1/2 second off)**

Procedure	Status	Corrective Action
9. Check cad cell sighting for view of flame <ul style="list-style-type: none"> <li>• Disconnect line voltage power and open line switch.</li> <li>• Unplug cad cell and clean cad cell face with soft clothe. Check sighting for clear view of flame. Replace cad cell in socket.</li> <li>• Reconnect line voltage power and close line switch.</li> <li>• Start burner.</li> </ul>	Burner locks out.	Go to step 10.
	Burner keeps running	System is OK.
	Burner keeps running.	System is OK.
10. Check cad cell. <ul style="list-style-type: none"> <li>• Disconnect line voltage power and open line switch.</li> <li>• Remove existing cad cell and replace with new cad cell.</li> <li>• Disconnect all wires from thermostat terminals to ensure that there is no call for heat.</li> <li>• Reconnect line voltage power and close line switch.</li> <li>• Expose new cad cell to bright light such as a flashlight.</li> </ul>	Indicator light is on.	Remount control onto burner housing. Go to step 6.
	Indicator light is off.	Go to step 11.
11. Check cad cell bracket assembly. <ul style="list-style-type: none"> <li>• Disconnect line voltage power and open line switch.</li> <li>• Remove cad cell wires from quick connect connectors on and leave control lead wires open.</li> <li>• Apply power to device.</li> <li>• Place jumper across cad cell terminals after burner motor turns on.</li> </ul>	Indicator light is on.	Replace cad cell bracket assembly.
	Indicator light is off.	Replace R7184.
NOTE: Restricted Mode - (Limited Reset): In order to limit the accumulation of unburned oil in the combustion chamber, the control can be reset only 3 times, after which, the control locks out. The reset count returns to zero each time a call for heat is successfully completed.		
NOTE: Disable function: Pressing and holding the reset button will disable all functions until the button is released. The burner will restart at the beginning of the normal heat cycle on SAFETY CHECK.		

**Table C4: System and General Troubleshooting**

<b>Problem</b>	<b>Possible Cause</b>	<b>Remedy</b>
Furnace will not start.	Thermostat not calling for heat.	Check thermostat and adjust. Also, check thermostat for accuracy; if it is a mercury switch type, it might be off level.
	No power to furnace.	Check furnace switch, main electrical panel furnace fuse or circuit breaker. Also look for any other hand operated switch, such as an old poorly located furnace switch, which was not removed during furnace replacement.
	Thermostat faulty.	Remove thermostat wires from oil primary control terminals T-T. Place a jumper across T-T. If furnace starts, replace thermostat, thermostat sub-base (if equipped), or both.
	Oil primary control faulty.	Check reset button on oil primary control. Remove thermostat wires from oil primary control terminals T1 - T2. Check for 24v across T -T. If no voltage is present, check for 115v to oil primary control. If 115v is present, go to Table C-3.
Furnace will not start.	Photo Cell wiring shorted or room light leaking into photo cell compartment	Check photo cell (cad cell) wiring for short circuits. Also, check for room light leaking into cad cell compartment. Repair light leak if necessary. See Table C-3.
	Open safety switch.	Check for open limit or auxiliary limit. Also, check internal wiring connections; loose connectors, etc.
Furnace will not start without first pushing oil primary control reset button. (Happens on frequent basis)	No fuel oil.	Check fuel oil supply. Check that all hand operated fuel oil valves are in the open position. Fill oil storage tank if necessary.
	Clogged nozzle.	Replace nozzle with high quality replacement. Use rating plate or Tables in Appendix A as a guide.
	Clogged oil filter.	Replace oil tank filter or in-line filter if used.
	Low oil pump pressure.	Connect pressure gauge to oil pump. Adjust pump pressure, or replace oil pump if necessary. Ensure that erratic pressure readings are not caused by defective fuel oil line.
	Air getting into fuel oil lines, or fuel oil line dirty, clogged, or in some manner defective.	Check fuel oil lines. Replace any compression fittings found with high quality flared fittings. Check for any signs of oil leaks. Any oil leak is a potential source of air or contaminants.
	Defective burner motor.	Check burner motor. If burner motor is cutting out on over-load, determine why. Replace if necessary.
Furnace starts, but cuts out requiring manually resetting the oil protector reset button.	Photo Cell (Cad Cell) defective.	If cad cell is dirty, clean it. (Determine why cad cell is getting dirty). If cad cell is poorly aimed, realign it. NOTE: The photocell should have a resistance of 100K $\Omega$ in absence of light; a maximum of 1500 $\Omega$ in the presence of light. Ensure that room light is not leaking into the cad cell compartment. (See diagnostic light section).
Furnace starts, but cuts out requiring manually resetting the oil protector reset button.	No fuel oil.	Check fuel oil supply. Check that all hand operated fuel oil valves are in the open position. Fill oil storage tank if necessary.
	Clogged nozzle.	Replace nozzle with high quality replacement. Use rating plate or Tables in Appendix A as a guide.
	Clogged oil filter.	Replace oil tank filter or in-line filter if used.
	Low oil pump pressure.	Connect pressure gauge to oil pump. Adjust pump pressure, or replace oil pump if necessary. Ensure that erratic pressure readings are not caused by defective fuel oil line.
	Air getting into fuel oil lines, or fuel oil line dirty, clogged, or in some manner defective.	Check fuel oil lines. Replace any compression fittings found with high quality flared fittings. Check for any signs of oil leaks. Any oil leak is a potential source of air or contaminants.
	Defective burner motor.	Check burner motor. If burner motor is cutting out on over-load, determine why. Replace if necessary.
	Water or contaminants in oil.	Drain fuel oil storage tank, replace fuel oil. (Consult with fuel oil supplier).
	Frozen oil line.	Gently warm oil line. Insulate oil line. (Outdoor piping size may require increased diameter).



<b>Problem</b>	<b>Possible Cause</b>	<b>Remedy</b>
Oil burner sputtering at nozzle	Electrodes out of adjustment or defective.	Check electrode settings. Check electrodes for dirt build-up or cracks in porcelain.
	Poor transformer high voltage connections or defective transformer.	Check contacts between the igniter and electrodes. If OK, replace the igniter
	Fuel oil filter clogged.	Replace fuel oil storage tank filter and / or fuel oil in-line filter.
	Defective oil pump.	Check burner motor / fuel oil pump coupling. Check oil pump pressure. Replace fuel oil pump if necessary.
	Fuel oil line partially clogged or contains air.	Bleed air from oil line. If problem persists, replace oil line.
Excessive fuel oil consumption.	System temperature rise too high.	System temperature rise ideally should not exceed 85°F. Check for clogged air filters. Check blower fan for excess dirt build-up or debris. Speed up blower fan if necessary.
	Poor "fan off" delay timing selection, (fan stops too soon).	Check "fan off" delay timing setting. Use a duct thermometer in the supply air plenum take-off or first few inches of the supply air trunk duct. Ideally, the fan will shut off at a temperature of 90° - 100°F. Manipulate the dip switch settings to come as close as possible to this "fan off" temperature.
	Fuel oil leak.	Check fuel oil line for leaks. Repair or replace if necessary.
	Stack temperature too high.	Check stack temperature. Stack temperatures will normally range from 350° to 450°F. Check draft regulator. Draft should be set to 0.02 in. w.c.
	Thermostat improperly adjusted or in poor location.	Check thermostat heat anticipator setting against measured amperage draw. Increase heat anticipator setting if necessary. If the thermostat is being influenced by drafts, sunlight, duct work, etc., relocate to more suitable location.
Too much smoke.	Insufficient combustion air adjustment at oil burner, or improper draft pressure.	Adjust the oil burner combustion air band and draft regulator to gain the highest practical CO <sub>2</sub> or lowest practical O <sub>2</sub> content in the flue gases. See Burner Set Up.
	Heat exchanger partially clogged.	Check for soot build-up in heat exchanger flue passages, especially in the outer radiator.
Soot building up on blast tube (end coning).	Poor alignment between oil burner blast tube and fire pot.	Check alignment. Blast tube should be centered with fire pot burner opening. Oil burner head should be ¼ inch back from the inside surface of the fire pot.
	Flame impingement caused by Incorrect nozzle angle.	Check nozzle size and angle. (See Appendix A). Check distance from head to inside surface of the fire pot.
	Defective fire-pot	Check fire-pot. Repair or replace.
Furnace will not warm home to desired temperature.	Airflow blocked or dirty air filter.	Clean or replace air filter.
	Thermostat adjustments or location.	Check thermostat heat anticipator setting against measured amperage draw. Increase heat anticipator setting if necessary. If the thermostat is being influenced by drafts, sunlight, duct work, etc., relocate to more suitable location.
	Insufficient airflow.	Check all dampers. Open closed dampers including registers in unused rooms. Check system temperature rise. If temperature rise is too high, speed up blower fan.
	Defective high limit control.	Test high limit function of all limit switches. Use a duct thermometer to assess accuracy of limit control. Check for obstructions to airflow around limit switch bi-metal elements. Replace control if necessary.
	Under-sized nozzle.	Check nozzle. If problem is not caused by air flow problems, use larger nozzle, if permitted by rating plate.
	Blower fan motor stopping intermittently on overload.	Check blower fan motor amperage draw. Check motor ventilation ports, clean if necessary. Replace motor if necessary.
	Burner motor stopping intermittently on overload.	Check burner motor. Replace if necessary.
Home does not heat evenly	Improper distribution of heat.	This is not likely to be a furnace problem. Balance duct system.

**Table C-4: System and General Troubleshooting *continued***

<b>Problem</b>	<b>Possible Cause</b>	<b>Remedy</b>
Supply air temperature too hot.	Airflow blocked or dirty air filter.	Clean or replace air filter.
	Insufficient airflow.	Check all dampers. Open closed dampers including registers in unused rooms. Check system temperature rise. If temperature rise is too high, speed up blower fan.
Supply air temperature too cool.	Excess airflow.	Check system temperature rise. Slow down blower fan if necessary.
	Excessive duct losses.	Check supply air ductwork. Seal leaky joints and seams. Insulate ductwork if necessary.
Supply air temperature too cool during first moments of furnace cycle.	Fan control "fan on" setting too low.	Increase differential between fan control "fan off" and "fan on" settings. (L4064B, L6064A fan / limit controls only, no adjustments available for L4064W fan / limit control). Register air deflectors may help.
	Excessive duct losses.	Check supply air ductwork. Seal leaky joints and seams. Insulate ductwork if necessary.

**FINAL CHECK OUT**

**ENSURE THAT ALL SAFETY DEVICES AND ELECTRICAL COMPONENTS HAVE BEEN SET FOR NORMAL OPERATION. ENSURE THAT ALL ELECTRICAL CONNECTIONS ARE TIGHT AND THAT THE WIRING IS SECURE.**



**IMPORTANT:**

Please ensure that the homeowner is informed and understands:

1. Where the circuit breaker or fuse is located in the main electrical panel.
2. Where the furnace switch is located, and the switch "on" and "off" positions if not obvious.

3. Where the oil shut-off valve from the oil storage tank is located.
4. How to operate the thermostat, and other related accessories.
5. How to operate the manual reset button on the primary control, and especially when not to push the reset button.
6. How and where to visually inspect the venting system for leaks or other problems.
7. How to inspect, clean and replace the air filter, and other homeowner maintenance procedures.
8. Who to call for emergency service and routine annual service.
9. The terms and conditions of the manufacturer's warranty and the contractor's warranty.

MODEL HTL-100C  
DIAGRAM

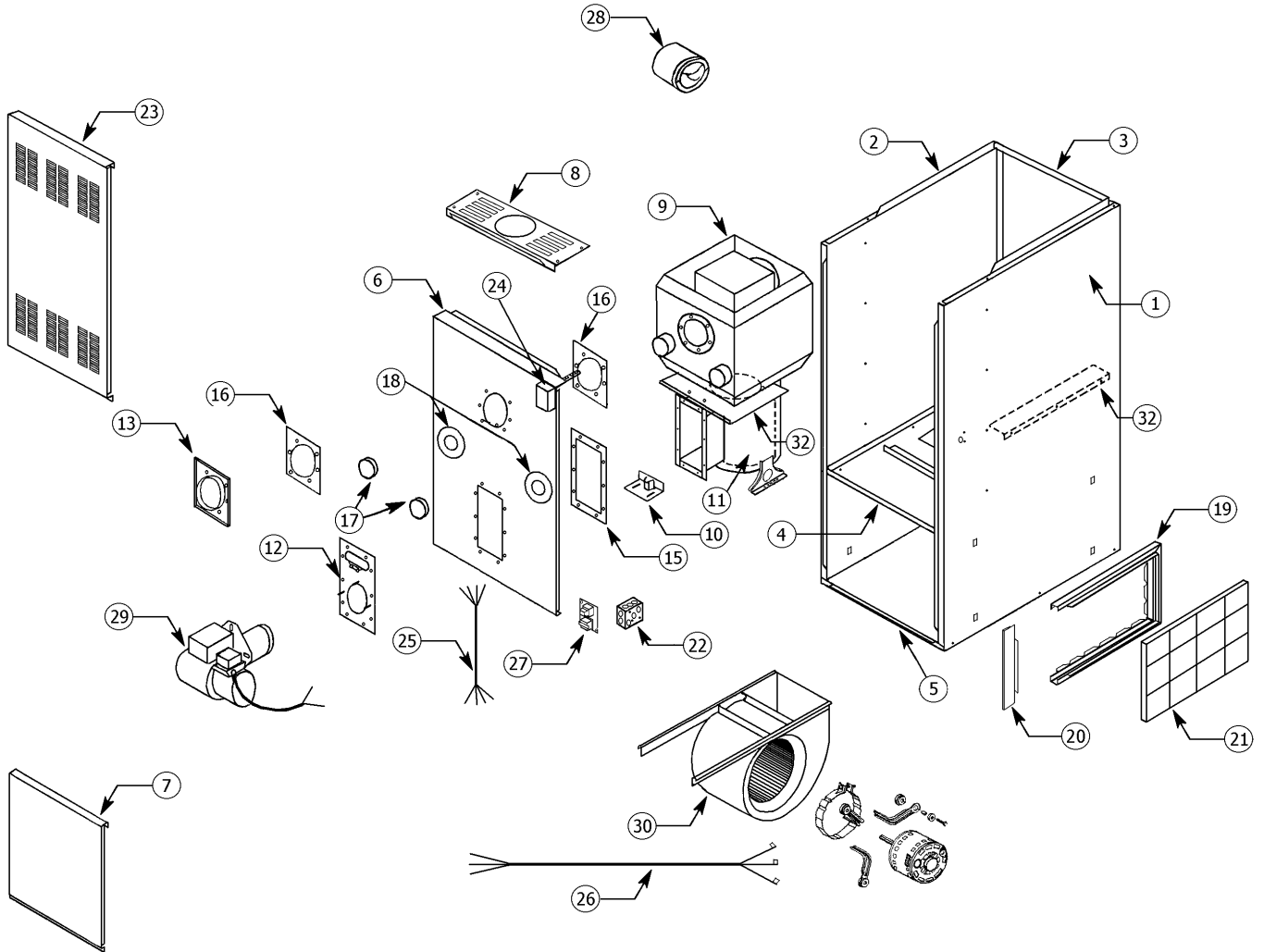

## PARTS LISTING: HIGHBOY MODEL: HTL 100C

Ref. No.	Description	HTL 100C Part No.
1	Right Side Panel Assembly	28456L
2	Left Side Panel Assembly	28457L
3	Rear Panel	26209L
4	Blower Division Assembly	28455
5	Base Panel	26216
6	Inner Front Panel	28428
7	Blower Access Panel	29122L
	Door Handle – P2-41	27368
8	Top Panel	21437L
9	Heat Exchanger Assembly	26569
10	Combustion Chamber Retainer Bracket	4141185A
11	Replacement Combustion Chamber	8823B1
12	Oil Burner Mounting Plate Assembly	29873
	Inspection Door Gasket	29871
13	Flue Collector Assembly	28306
15	Pouch Gasket	28645
16	Flue Collar Gasket (2 per unit)	21994
17	Radiator Cleanout Cover (2 per unit)	1061A
18	Casing Cleanout Cover (2 per unit)	3011325A
19	Filter Frame 16" X 25"	18020
20	Filter Frame End Support	5592B2
21	Filter 16" X 25" Permanent	2180023
22	Junction Box	21318
23	Upper Door Panel	21338L
	Logo Bezel	28479
	Logo Label	28563
24	Fan & Limit L6064A1003B 11" Set @ 210° F (HTL C only)	18121
25	Wire Harness, Fan & Limit	29422
26	Wire Harness, Blower	26591
27	Fan Center, 40 va, SPDT, 57-01V18BC4E231	27740
	Replacement Relay	27767
28	Draft Regulator	12240 (6")
29	Oil Burner Assembly, Beckett AF65XN	29593
	Burner Motor 1/7 HP 3450 RPM PSC	29689
	Beckett Clean-cut Oil Pump A2EA6520	29688
	Solid State Ignitor FRANCE 10SAY-01	29522
	Primary Combustion Control R7184B	29664
	Air Tube Combination AF65XN (HTL C only)	11986
	Flame Retention Head	11961 (F3)
	Nozzle, .85/80°A (HTL-100C only)	2100036

## PARTS LISTING: HIGHBOY MODEL: HTL 100C

Ref. No.	Description	HTL 100C Part No.
30	Blower Assembly Direct Drive	26564
	Blower Housing and Wheel, G10 DD	15011
	Blower Wheel, G10 DD	26430
	Blower Motor, 1/2 hp, 4-Speed	26088
	Motor Mounting Band – TR6884B	17811
	Motor Mount Arms – 10-10 DD Blower (3 per unit)	26251
	Motor Run Capacitor, 10 mfd @ 370 vac	27743
	Capacitor Strap	27760
	Capacitor Insulator	27769
	Blower Slide Rail 2 Per	18189
	30	Blower Assembly Belt Drive
Blower Housing and Wheel, G10		10361
Blower Wheel, G10		26589
Blower Motor, 1/2 hp, Single-Speed		28006
Motor Pulley 3 1/4 X 1/2 Adjustable		2240001
Blower Pulley 5 X 3/4		2240005
Fan Belt 4L Series		2240065 (35")
	Blower Slide Rail 2 Per	18189
32	Heat Exchanger, Air Baffle HTL 100C	26236

**All parts are the same as listed on the previous pages for Model HTL 100C except where noted below.**

4	Blower Division Assembly	29116
26	Wire Harness, Blower	29119
27	Fan Center, Assembly 40 va, SPDT	26857
	Replacement Relay R8228B1012B	26854
30	Blower Assembly HTL 100CT	29117
	Blower Housing and Wheel, DCT1220 1104 DD	26855
	Blower Wheel, 12-11 DD	26653
	Blower Motor, 1 hp, 3-Speed	26826
	Motor Mounting Band – TR6884B	17811
	Motor Mount Arms 12-11 DD Blower (3 per unit)	17812
	Motor Run Capacitor, 20 mfd @ 370 vac	27745
	Capacitor Strap	27761
	Capacitor Insulator	27768
	Blower Slide Rail 2 Per	18189
		Terminal Block EE8-201
	Fuse ABC 15 Amp Slow Blow	2200096
	Fuse Holder HKP-HH BCL	27089

**HOMEOWNER'S REFERENCE TABLE**

Model No.	
Serial No.	
Date Installed	
Contractor	
Contact	
Address	
Postal Code	
Telephone No.	
After Hours No.	

**If different from Installation Contractor:**

Service Tech.	
Telephone No.	
After Hours No.	

**Fuel Supplier**

Fuel Oil Supplier	
Contact	
Telephone No.	
After Hours No.	

**NOTES:**



**ECR International**

6800 Base Line, Wallaceburg, Ontario, N8A 5E5, Can. Tel: (519) 627-0791 Fax: (519) 627-4719

2201 Dwyer Avenue, Utica, New York, 13504, USA. Tel: (315) 797-1310 Fax: (315) 724-9319

85 Middle Road, Dunkirk, New York, 14048, USA Tel: (716) 366-5500 Fax: (716) 366-1209

**[www.ecrinternational.com](http://www.ecrinternational.com)**